

Zener Voltage Regulators

200 mW SOD-323 Surface Mount

This series of Zener diodes is packaged in a SOD-323 surface mount package that has a power dissipation of 200 mW. They are designed to provide voltage regulation protection and are especially attractive in situations where space is at a premium. They are well suited for applications such as cellular phones, hand held portables, and high density PC boards.

Specification Features:

- Standard Zener Breakdown Voltage Range – 2.0 V to 75 V
- Steady State Power Rating of 200 mW
- Small Body Outline Dimensions: 0.067" x 0.049"(1.7 mm x 1.25 mm)
- Low Body Height: 0.035" (0.9 mm)
- Package Weight: 4.507mg/unit
- ESD Rating of Class 3 per Human Body Model
- Pb-Free package is available.
- S- Prefix for Automotive and Other Applications Requiring Unique Site and Control Change Requirements; AEC-Q101 Qualified and PPAP Capable.
- We declare that the material of product compliance with RoHS requirements.

Mechanical Characteristics:

CASE: Void-free, transfer-molded plastic

FINISH: All external surfaces are corrosion resistant

MAXIMUM CASE TEMPERATURE FOR SOLDERING PURPOSES:

260°C for 10 Seconds

POLARITY: Cathode indicated by polarity band

FLAMMABILITY RATING: UL94 V-0

MOUNTING POSITION: Any

ORDERING INFORMATION

Device	Package	Shipping
LM3Z2V0T1G Series	SOD-323	3000/Tape&Reel
LM3Z2V0T3G Series	SOD-323	10000/Tape&Reel

MAXIMUM RATINGS

Rating	Symbol	Max	Unit
Total Device Dissipation FR-5 Board(Note 1.) @ TA = 25°C	P_D	200	mW
Derate above 25°C		1.5	mW/°C
Thermal Resistance from Junction to Ambient	$R_{\theta JA}$	635	°C/W
Junction and Storage Temperature Range	T_J, T_{stg}	-65 to+150	°C

1. FR-4 Minimum Pad

LM3Z2V0T1G Series S-LM3Z2V0T1G Series

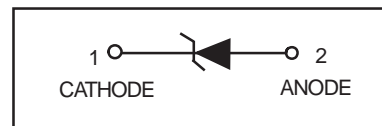
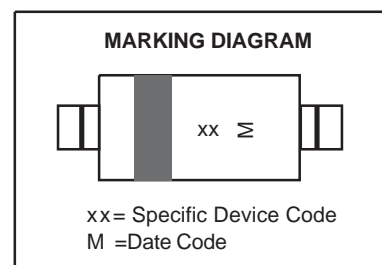
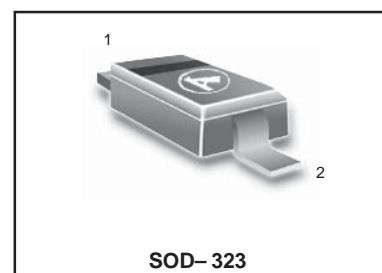

ELECTRICAL CHARACTERISTICS

($T_A = 25^\circ\text{C}$ unless otherwise noted,
 $V_F = 0.9\text{ V Max. @ } I_F = 10\text{ mA}$ for all types)

Symbol	Parameter
V_Z	Reverse Zener Voltage @ I_{ZT}
I_{ZT}	Reverse Current
Z_{ZT}	Maximum Zener Impedance @ I_{ZT}
I_{ZK}	Reverse Current
Z_{ZK}	Maximum Zener Impedance @ I_{ZK}
I_R	Reverse Leakage Current @ V_R
V_R	Reverse Voltage
I_F	Forward Current
V_F	Forward Voltage @ I_F
Θ_{VZ}	Maximum Temperature Coefficient of V_Z
C	Max. Capacitance @ $V_R = 0$ and $f = 1\text{ MHz}$

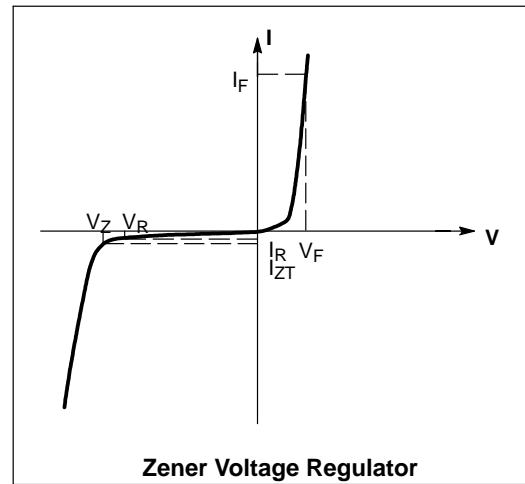

ELECTRICAL CHARACTERISTICS (T_A = 25°C unless otherwise noted, V_F = 0.9 V Max. @ I_F = 10 mA for all types)

Device	Device Marking	Zener Voltage (Note 2.)			Zener Impedance			Leakage Current		θV _Z (mV/k) @ I _{ZT}		C @ V _R = 0 f = 1 MHz	
		V _Z (Volts)			@ I _{ZT}	Z _{ZT} @ I _{ZT}	Z _{ZK} @ I _{ZK}		I _R @ V _R		Min		Max
		Min	Nom	Max	mA	Ω	Ω	mA	μA	Volts		pF	
LM3Z2V0T1G	WY	1.91	2.0	2.09	5	100	600	1.0	150	1.0	-3.5	0	450
LM3Z2V4T1G	00	2.2	2.4	2.6	5	100	1000	0.5	50	1.0	-3.5	0	450
LM3Z2V7T1G	01	2.5	2.7	2.9	5	100	1000	0.5	20	1.0	-3.5	0	450
LM3Z3V0T1G	02	2.8	3.0	3.2	5	100	1000	0.5	10	1.0	-3.5	0	450
LM3Z3V3T1G	05	3.1	3.3	3.5	5	95	1000	0.5	5	1.0	-3.5	0	450
LM3Z3V6T1G	06	3.4	3.6	3.8	5	90	1000	0.5	5	1.0	-3.5	0	450
LM3Z3V9T1G	07	3.7	3.9	4.1	5	90	1000	0.5	3	1.0	-3.5	-2.5	450
LM3Z4V3T1G	08	4.0	4.3	4.6	5	90	1000	0.5	3	1.0	-3.5	0	450
LM3Z4V7T1G	09	4.4	4.7	5.0	5	80	800	0.5	3	2.0	-3.5	0.2	260
LM3Z5V1T1G	0A	4.8	5.1	5.4	5	60	800	0.5	2	2.0	-2.7	1.2	225
LM3Z5V6T1G	0C	5.2	5.6	6.0	5	40	700	0.5	1	2.0	-2.0	2.5	200
LM3Z6V2T1G	0E	5.8	6.2	6.6	5	10	100	0.5	3	4.0	0.4	3.7	185
LM3Z6V8T1G	0F	6.4	6.8	7.2	5	15	160	0.5	2	4.0	1.2	4.5	155
LM3Z7V5T1G	0G	7.0	7.5	7.9	5	15	160	0.5	1	5.0	2.5	5.3	140
LM3Z8V2T1G	0H	7.7	8.2	8.7	5	15	160	0.5	0.7	5.0	3.2	6.2	135
LM3Z9V1T1G	0K	8.5	9.1	9.6	5	15	160	0.5	0.2	7.0	3.8	7.0	130
LM3Z10VT1G	0L	9.4	10	10.6	5	20	160	0.5	0.1	8.0	4.5	8.0	130
LM3Z11VT1G	0M	10.4	11	11.6	5	20	160	0.5	0.1	8.0	5.4	9.0	130
LM3Z12VT1G	0N	11.4	12	12.7	5	25	80	0.5	0.1	8.0	6.0	10	130
LM3Z13VT1G	0P	12.4	13.25	14.1	5	30	80	0.5	0.1	8.0	7.0	11	120
LM3Z15VT1G	0T	14.3	15	15.8	5	30	400	0.5	0.05	10.5	9.2	13	110
LM3Z16VT1G	0U	15.3	16.2	17.1	5	40	400	0.5	0.05	11.2	10.4	14	105
LM3Z18VT1G	0W	16.8	18	19.1	5	45	400	0.5	0.05	12.6	12.4	16	100
LM3Z20VT1G	0Z	18.8	20	21.2	5	55	500	0.5	0.05	14.0	14.4	18	85
LM3Z22VT1G	10	20.8	22	23.3	5	55	500	0.5	0.05	15.4	16.4	20	85
LM3Z24VT1G	11	22.8	24.2	25.6	5	70	120	0.5	0.05	16.8	18.4	22	80
LM3Z27VT1G	12	25.1	27	28.9	2	80	300	0.5	0.05	18.9	21.4	25.3	70
LM3Z30VT1G	14	28	30	32	2	80	300	0.5	0.05	21.0	24.4	29.4	70
LM3Z33VT1G	18	31	33	35	2	80	300	0.5	0.05	23.2	27.4	33.4	70
LM3Z36VT1G	19	34	36	38	2	90	500	0.5	0.05	25.2	30.4	37.4	70
LM3Z39VT1G	20	37	39	41	2	130	500	0.5	0.05	27.3	33.4	41.2	45
LM3Z43VT1G	21	40	43	46	2	150	500	0.5	0.05	30.1	37.6	46.6	40
LM3Z47VT1G	1A	44	47	50	2	170	500	0.5	0.05	32.9	42.0	51.8	40
LM3Z51VT1G	1C	48	51	54	2	180	500	0.5	0.05	35.7	46.6	57.2	40
LM3Z56VT1G	1D	52	56	60	2	200	500	0.5	0.05	39.2	52.2	63.8	40
LM3Z62VT1G	1E	58	62	66	2	215	500	0.5	0.05	43.4	58.8	71.6	35
LM3Z68VT1G	1F	64	68	72	2	240	500	0.5	0.05	47.6	65.6	79.8	35
LM3Z75VT1G	1G	70	75	79	2	255	500	0.5	0.05	52.5	73.4	88.6	35

2. Zener voltage is measured with a pulse test current I_Z at an ambient temperature of 25°C.

Typical Characteristics

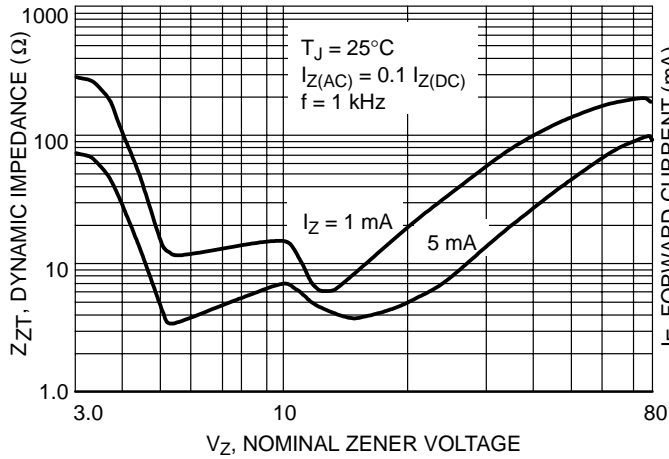

Figure 1. Effect of Zener Voltage on Zener Impedance

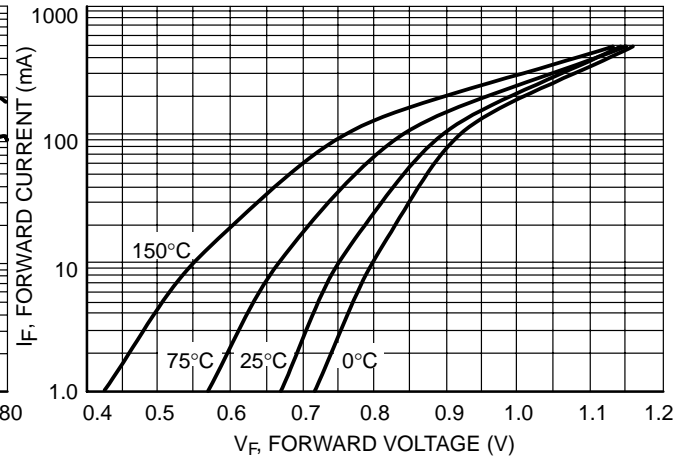

Figure 2. Typical Forward Voltage

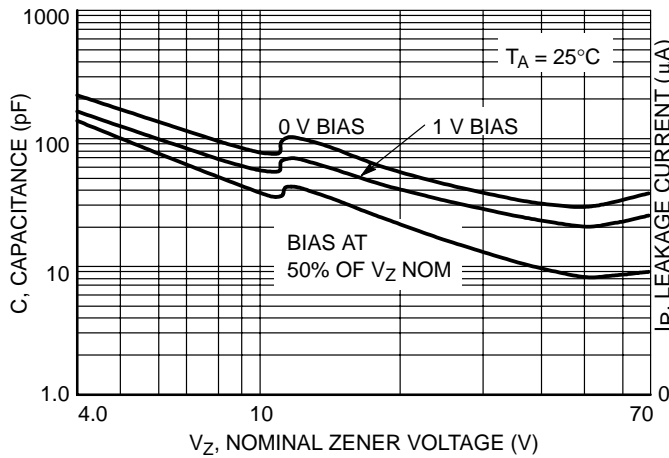

Figure 3. Typical Capacitance

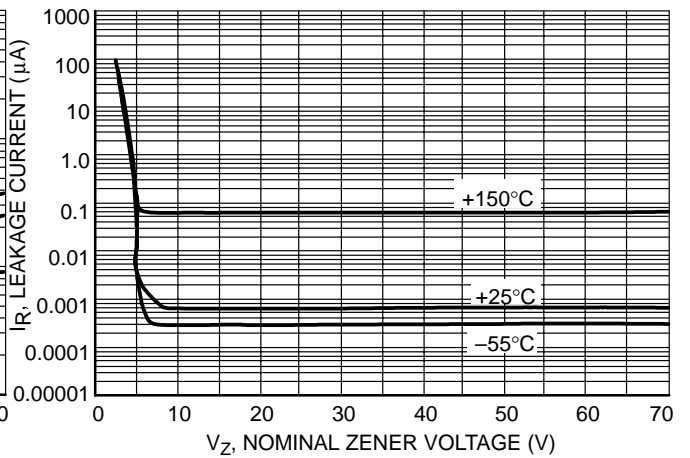

Figure 4. Typical Leakage Current

Typical Characteristics

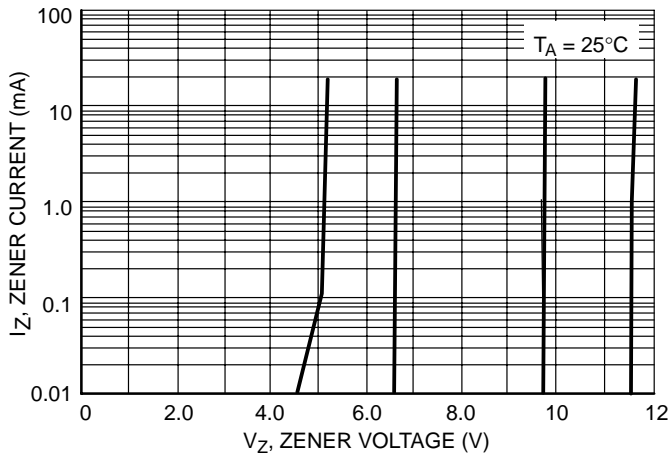

Figure 5. Zener Voltage versus Zener Current (V_Z Up to 12 V)

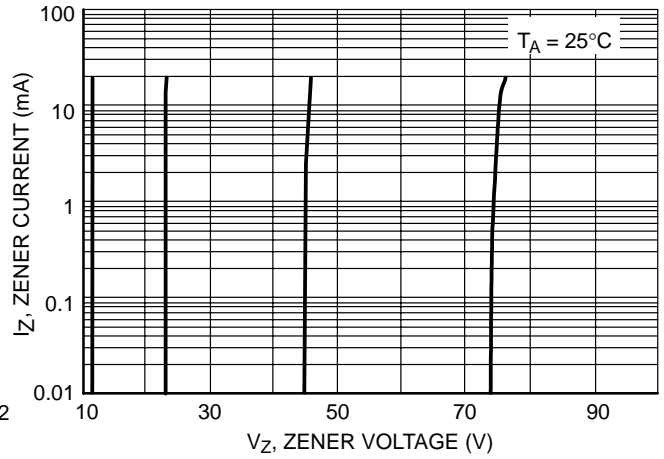

Figure 6. Zener Voltage versus Zener Current (12 V to 75 V)

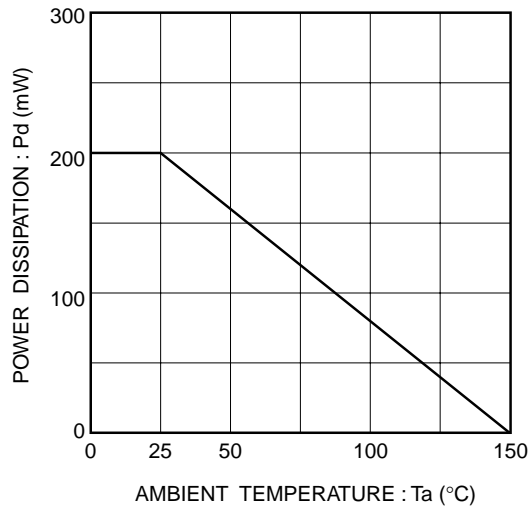
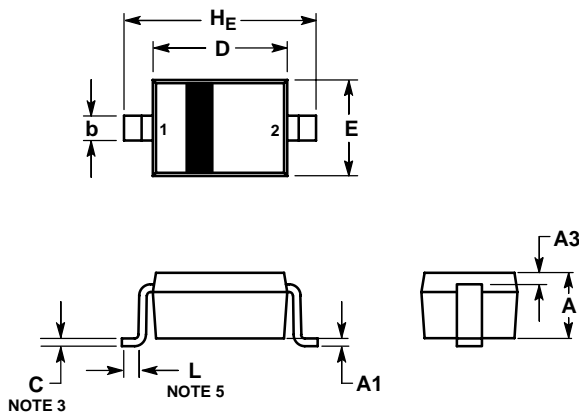

Figure 7. Steady State Power Derating

PACKAGE DIMENSIONS SOD-323



NOTES:

1. DIMENSIONING AND TOLERANCING PER ANSI Y14.5M, 1982.
2. CONTROLLING DIMENSION: MILLIMETERS.
3. LEAD THICKNESS SPECIFIED PER L/F DRAWING WITH SOLDER PLATING.
4. DIMENSIONS A AND B DO NOT INCLUDE MOLD FLASH, PROTRUSIONS OR GATE BURRS.
5. DIMENSION L IS MEASURED FROM END OF RADIUS.

DIM	MILLIMETERS			INCHES		
	MIN	NOM	MAX	MIN	NOM	MAX
A	0.80	0.90	1.00	0.031	0.035	0.040
A1	0.00	0.05	0.10	0.000	0.002	0.004
A3	0.15 REF			0.006 REF		
b	0.25	0.32	0.4	0.010	0.012	0.016
C	0.089	0.12	0.177	0.003	0.005	0.007
D	1.60	1.70	1.80	0.062	0.066	0.070
E	1.15	1.25	1.35	0.045	0.049	0.053
L	0.08			0.003		
HE	2.30	2.50	2.70	0.090	0.098	0.105

SOLDERING FOOTPRINT*

